

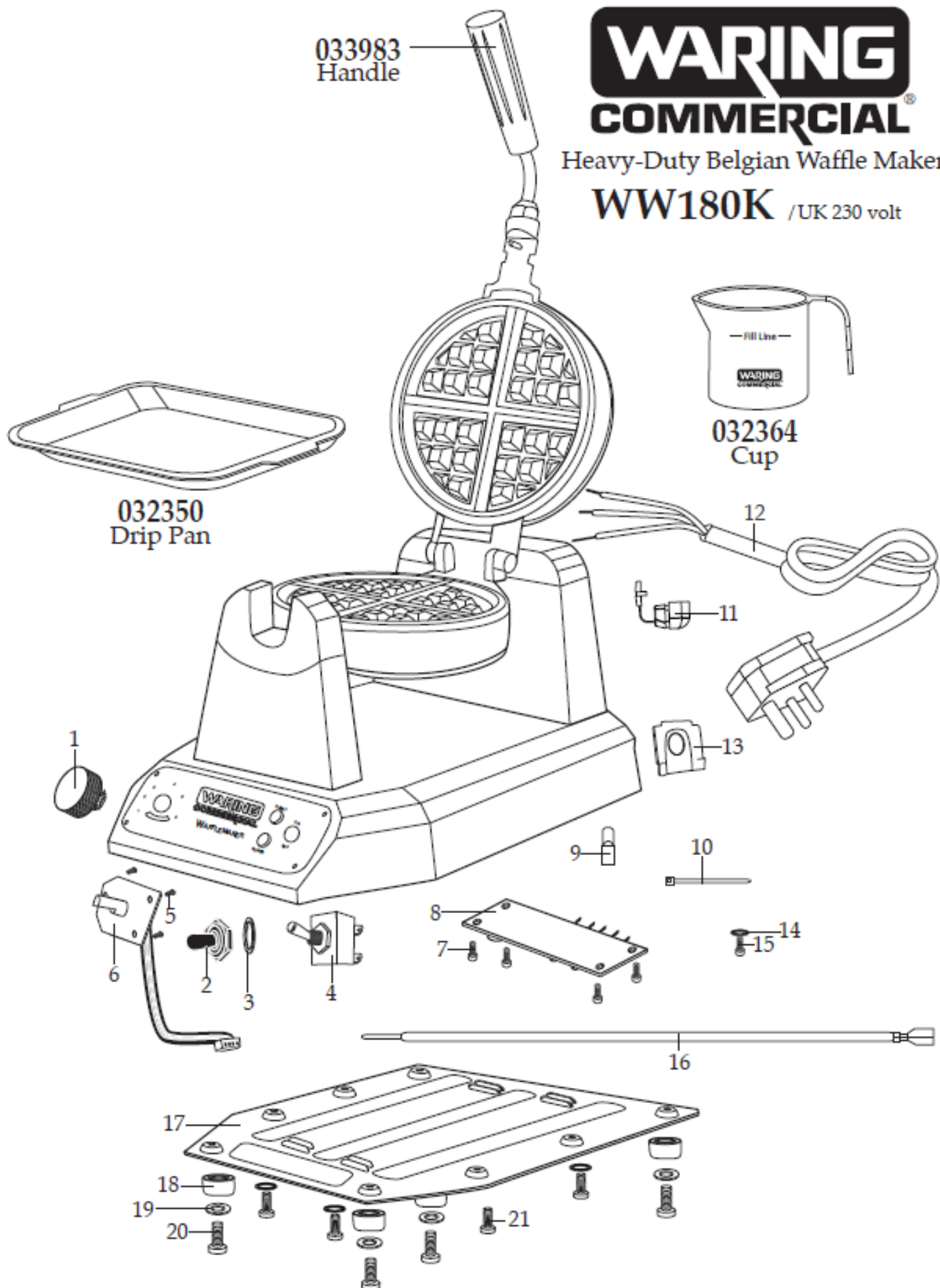























Heavy-Duty Belgian Waffle Maker

WW180K /UK 230 volt



## Exploded diagram and spare parts list – DM873

Machine	Explode	Code	Description
DM873 - Waring Single Waffle Maker	1		Control Knob With Insert
DM873 - Waring Single Waffle Maker	2	WA079	Switch Boot
DM873 - Waring Single Waffle Maker	3		Washer
DM873 - Waring Single Waffle Maker	4		On/Off Toggle Switch
DM873 - Waring Single Waffle Maker	5		Screw (3 required)
DM873 - Waring Single Waffle Maker	6		Darkness Control Panel
DM873 - Waring Single Waffle Maker	7		Screw (4 required)
DM873 - Waring Single Waffle Maker	8		PCB
DM873 - Waring Single Waffle Maker	9		Large Crimp Connection (2 required)
DM873 - Waring Single Waffle Maker	9		Small Crimp Connection (4 required)
DM873 - Waring Single Waffle Maker	10		Wire Tie (7 required)
DM873 - Waring Single Waffle Maker	11		Strain Relief
DM873 - Waring Single Waffle Maker	12		Cord Set
DM873 - Waring Single Waffle Maker	13		Cord Plate
DM873 - Waring Single Waffle Maker	14		Ground Spring Washer (2 required)
DM873 - Waring Single Waffle Maker	15		Ground Screw (2 required)
DM873 - Waring Single Waffle Maker	16		Red Lead
DM873 - Waring Single Waffle Maker	17		Bottom Plate
DM873 - Waring Single Waffle Maker	18		Foot (4 required)
DM873 - Waring Single Waffle Maker	19		Foot Washer (4 required)
DM873 - Waring Single Waffle Maker	20		Foot Screw (4 required)
DM873 - Waring Single Waffle Maker	21		Screw (4 required)
DM873 - Waring Single Waffle Maker	Not Numbered	033983	Handle
DM873 - Waring Single Waffle Maker	Not Numbered	032350	Drip Pan
DM873 - Waring Single Waffle Maker	Not Numbered	032364	Cup